

Data Sheet



Article number: 071051300165020

Description: Cardan drive shaft 0.105.130.001
S=165 X=20 Bore with keyway

Measures

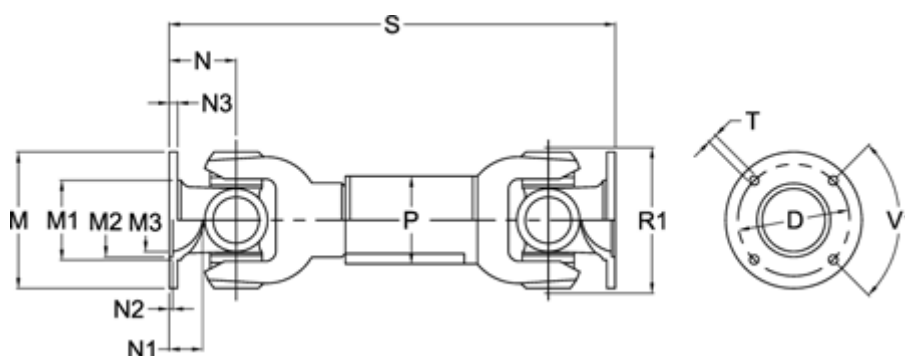

D	= 47 +-0,1	N1	= 10	T	= 5 B12
Extension X	= 20	N2	= 1,5 +0,3	V1 degrees	= 90
Flange diameter M	= 58	N3	= 3.5		
M1	= 35	Number og Flangeholes	= 4		
M2	= 30	P	= 28x1,5		
M3	= 26	R1	= 52		
Max. Bending Angle degrees	= 30	S min	= 165		
N	= 30	Spline dim. DIN 5480	= 20x1,5x12		